



**Quantum® Hardcoated Polycarbonate  
Street Shield™ Windshield  
N25010, 7/8" (22mm) Bars  
N25012, 1" (25mm) Bars and  
N25014, 1.25" (31.5mm) Bars**

**Thank you for purchasing a National Cycle product. Read these instructions carefully and thoroughly before beginning work. Dealers, if installing this windscreen for a customer, please give them this manual. It contains information needed to properly maintain and use this product.**

**Attention**



Special notes and cautionary measures which can prevent damage to the accessory or motorcycle.

**Note**



Tips for facilitation of operation, control and adjustment, as well as maintenance.



National Cycle Shield Wash™ (N1401-01) makes a good daily cleaner and comes with a handy travel size bottle. Shield Wash is safe for all windshields and helmet visors.

Do not clean polycarbonate in hot sun or high temperatures. Do not clean the screen with glass cleaners.

Do not allow brake fluid, alcohol, or strong solvents to contact the screen.

**CLEANING AND MAINTENANCE**

To clean the screen, wash with a clean soft cloth, plenty of warm water and if necessary, a non-abrasive soap such as dishwashing liquid. Flannel or soft chamois make good cleaning cloths. Paint, glue residue or grease removal: Moisten cotton with naphtha or turpentine followed by a wash as above.

**RAIN REPELLENT**

Do not use rain protective products made for glass. We recommend National Cycle's RainZip® (N1410-01) to keep your windshield clear in rainy weather.



**Register your windshield online at [www.nationalcycle.com](http://www.nationalcycle.com)  
National Cycle 3-Year Limited Warranty**

National Cycle hereby warrants to the original registered owner of a National Cycle polycarbonate windshield for a period of three years from the date of purchase against breakage. This limited warranty is expressly limited to the replacement of the polycarbonate windscreen. This limited warranty does not include scratches, coating failure, cosmetic wear and tear, replacement of hardware, or any consequential damages or expenses including labor cost of installation, removal and/or replacement, inconvenience, inbound freight expenses or damage to

any other component of the motorcycle or any other accessories. Certain chemicals, generally known as acidic hydrocarbons, are known to cause polycarbonate damage and will not be covered under this limited warranty. Please refer to the cleaning instructions supplied with all National Cycle windshields.

**Visit [www.nationalcycle.com](http://www.nationalcycle.com) for further details, or call or write National Cycle**

**! WARNING**

Never ride your motorcycle with loose accessory mounting hardware. Check the hardware for tightness regularly.

Today's motorcycles are built with enough frame rigidity to withstand the moderate loads imposed on them by the foreseeable addition of an accessory(ies). If an accessory(ies) adversely affects your motorcycle's stability, immediately remove the accessory(ies). Do not ride a motorcycle that exhibits unsafe handling traits.

Have experienced service personnel correct any problem before riding with the accessory(ies) installed. For further questions concerning handling problems associated with an accessory(ies), contact your dealer, motorcycle manufacturer, or accessory manufacturer.

Sunlight reflected off the inside curvature of the windscreen can, at certain times of day, cause extreme heat buildup on the motorcycle instruments and possibly even melt them. Exercise care in parking to avoid this. Park your motorcycle facing the sun or place an opaque object over this area.

Parts List				Notes and Tools
Item	Part Number	Description	Qty.	
1	24083	Street Shield, Screen	1	Screen with Mount Points Attached, No Kit
	<b>Kit-N25000</b>	Complete Mount Kit	1	Mount Kit Only
	<b>Bag #079</b>			
2	42-429000-000	Nut, Upper Locking	2	3/4" Box Wrench or 19mm Box Wrench
3	34-343560-000	Lower and Upper Rods, 5/16"	4	
	<b>Bag #1145</b>			
4	37-400640-000	Fork Clamp, SS #24	2	Flat Blade Screw Driver
5	42-451105-000	Locking Nut, Lower	2	5/8" Box Wrench or Adjustable Wrench, Small Cloth for Protection
6	44-449450-000	Fork Boss	2	
7	44-449455-000	Collet Tube, Left	1	
8	44-449456-000	Collet Tube, Right	1	
9	44-449460-000	Wing Screw	2	
	<b>Bag #052</b>			
10	44-440300-000	Bracket, Telescope, Left	1	
11	44-440600-000	Bracket, Telescope, Right	1	
12	44-440400-000	Knob, QuickSet	2	
	<b>Bag #051, #077, #078</b>			
13	59-515200-000	Screws, 1/4 -20	4	Included in Bag#051, 077 and 078
14	44-446700-000	Tape, Double Stick	2	Included in Bag#051, 077 and 078
15	59-515100-000	Hex Key	1	Included in Bag#051, 077 and 078
	<b>Bag #051</b>			<b>Bag#051 included in Kit- N25010 for 7/8" (22mm) Bars</b>
16	44-440100-000	Pivot Strap, 7/8" (22mm)	2	For 7/8" (22mm) Diameter Handlebars
17	44-440200-000	Pivot Mount, 7/8" (22mm)	2	For 7/8" (22mm) Diameter Handlebars
	<b>Bag #077</b>			<b>Bag#077 included in Kit- N25012 for 1" (25mm) Bars</b>
16	44-440110-000	Pivot Strap, 1" (25mm)	2	For 1" (25mm) Diameter Handlebars
17	44-440210-000	Pivot Mount, 1" (25mm)	2	For 1" (25mm) Diameter Handlebars
	<b>Bag #078</b>			<b>Bag#078 included in Kit- N25014 for 1.25" (31.5mm) Bars</b>
16	44-440120-000	Pivot Strap, 1.25" (31.5mm)	2	For 1.25" (31.5mm) Diameter Handlebars
17	44-440220-000	Pivot Mount, 1.25" (31.5mm)	2	For 1.25" (31.5mm) Diameter Handlebars

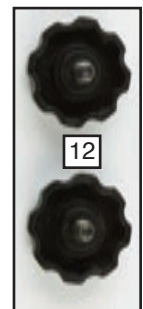
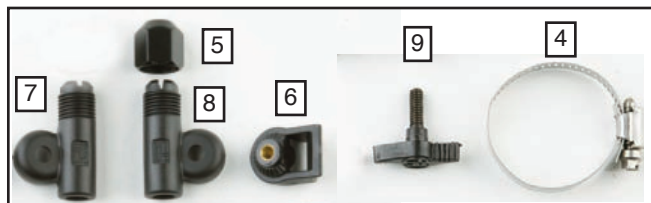
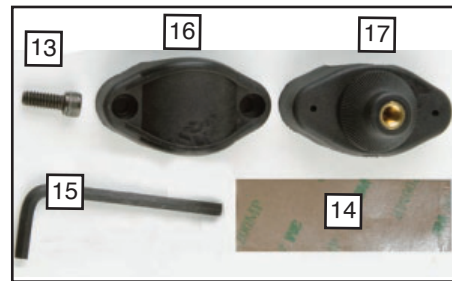
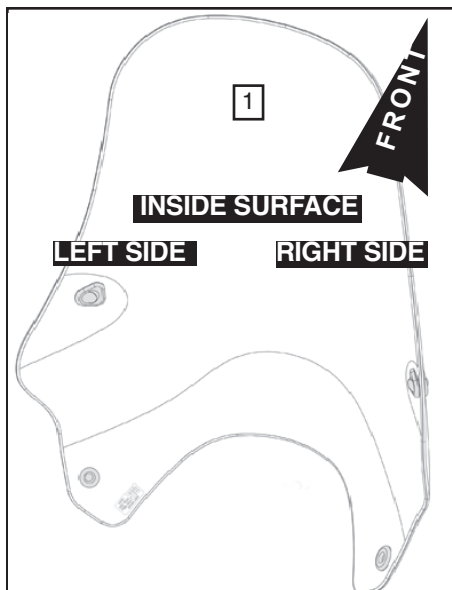

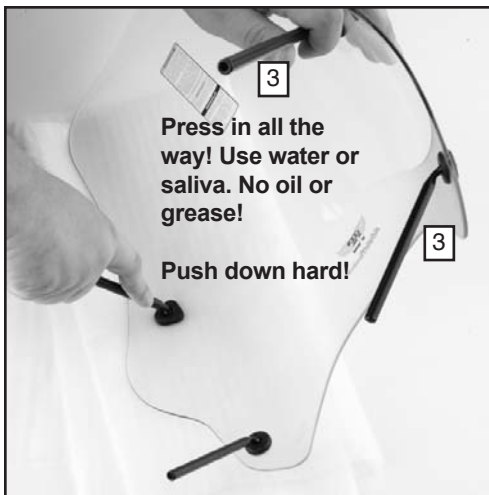

Figure 1



Figure 2

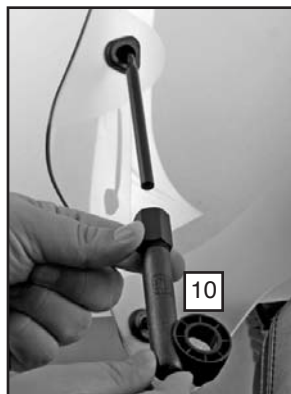

Figure 3

## PREPARATION

1. Position motorcycle securely on its side stand.

## INSTALLATION

### INSTALL UPPER AND LOWER RODS TO SHIELD

1. Install the Upper Rods (3) and Lower Rods (3) into Ball Sockets. Place shield face down on smooth, non-scratching, well supported surface. Wet the upright ball with saliva; **do not** use oil, grease, or silicone as lubricant. Push upright ball into socket until seated, it will “pop” into place. Do this at all four sockets. **Figure 1**

### INSTALL LOCKING NUTS

2. Loosely screw one Locking Nut (2) onto each Telescope Bracket. **Figure 2.**

3. Slide the Left Telescope Bracket (10) Assembly on the Left Rod. Repeat on Right Side. Finger tighten. **Figure 3.**

## ADJUSTABLE- SELECT BEST LOCATION



Figure 4

### DETERMINE BEST LOCATION TO MOUNT PIVOT MOUNTS

4. Hold shield to motorcycle and select the best location around a vertical section of the handlebar to mount the Pivot Mounts (17). **Figure 4**

**Do not install the Double Stick Tape (14) in the next step. It will be done later.**

5. Place Pivot Mount (17) on handlebar. Compress Pivot Mount along with Pivot Strap (16) and start the two 1/4-20 Hex Screws (13). **Do Not Tighten. (Hex Key Wrench) (15). Figure 4**

6. Adjust the Pivot Mounts up or down on the handlebars. Repeat on opposite side. Be sure both sides are symmetrical. **Figure 4**

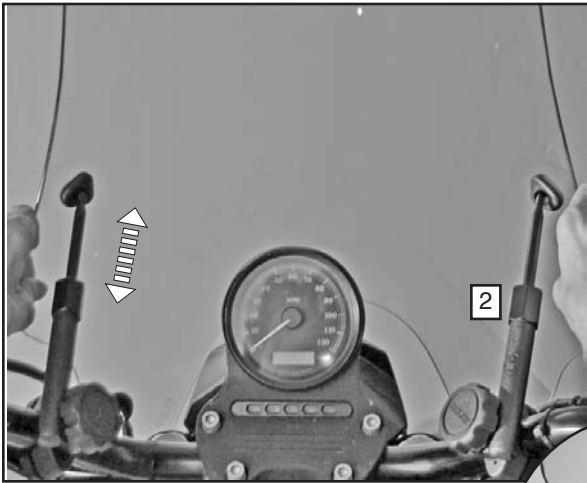
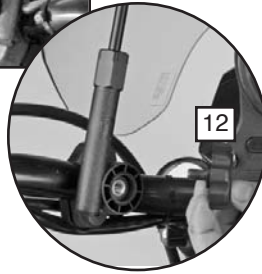

Figure 5



**Use Tape or Grease Pencil to Mark the location of the Pivot Mounts**



Figure 6



Figure 7



Figure 8

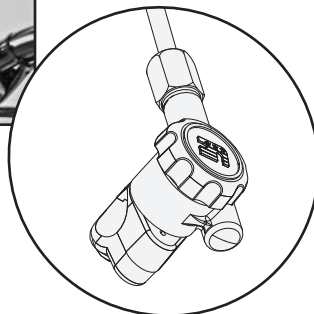

7. Set the Screen assembly over the headlight and attach the Telescope Brackets (10 and 11) to the Quick-Set Pivot Mounts with QuickSet Knobs (12). **Figure 5**

A. Set the screen close to the headlight at the desired rake angle.

8. Sit On The Bike and adjust the Upright extension from the Telescope Brackets. **Figure 5**

B. For the most rigid installation, Minimize the Upright extension from the Telescope Brackets.

C. Slide the handlebar Pivot Mount assemblies further up the bar to reduce extension.

9. When satisfied with position of screen, hand tighten the Locking Nuts (2). **Figure 5**

10. Now remove Quick Set Knobs to remove the screen.

11. Mark the placement and rotational position of the Pivot Mounts on the handlebars, then remove the Pivot Mounts and Straps. **(Tape) Figure 6**

12. Place one piece of Double Stick Tape (14) at the location on each handlebar where the Pivot Mounts were placed. Reinstall the Pivot Mounts. **Figure 7**

#### **INSTALL WINDSHIELD**

13. Install the Windshield Assembly to the Pivot Mounts with the QuickSet Knobs.

 **At this time, DO NOT fully tighten upper assembly.**



Figure 9

## INSTALL LOWER FORK HARDWARE

14. Install one Lower Lock Nut to each Collet Tube. Hand Tighten. **Figure 9**
15. Slide the Left Collet Tube onto the Left Lower Rod. Determine where to mount the Fork Boss. **Figure 10 and 10a**
16. Thread one Fork Boss through a hose clamp. Loosely attached Hose Clamp to fork. Screw head of Hose Clamp faces to the rear of the motorcycle. (Flat Blade Screw Driver) **Figure 10 and 10a**

### ADJUSTABLE- SELECT BEST LOCATION

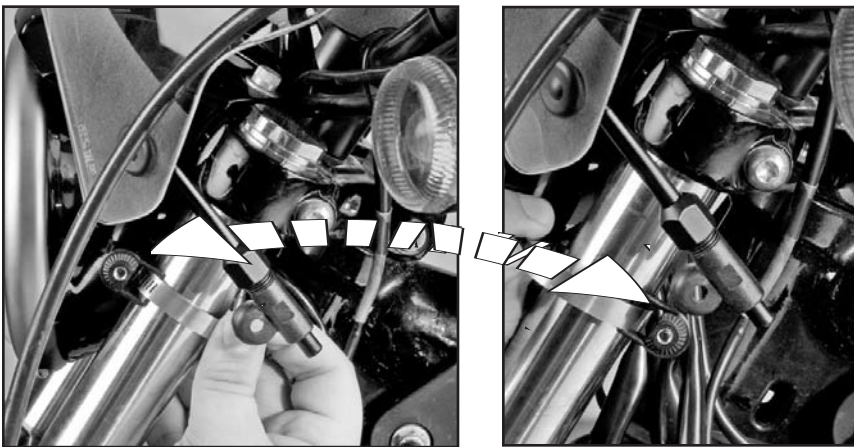

Figure 10

### CHECK CLEARANCE and TIGHTEN HARDWARE

17. When the desired height and position of the screen is adjusted, carefully move the front forks left and right to make sure the Upper Rods and the Lower Rods **Do Not** contact the frame or gas tank. If the Rods are too long, they can be trimmed with a fine hacksaw blade and touched up with a rust-inhibiting black paint.



### TIGHTEN HARDWARE

18. **Tighten Securely. Figure 10a and 11**
  - a. The Pivot Mounts and Pivot Straps. (3/16" Hex Key)
  - b. The Locking Nuts. (3/4" or Adjustable Wrench, Cloth for Protection)
  - c. Wing Screws on Lower Fork Boss
  - d. Fork Hose Clamps on Fork (Flat Blade Screw Driver)

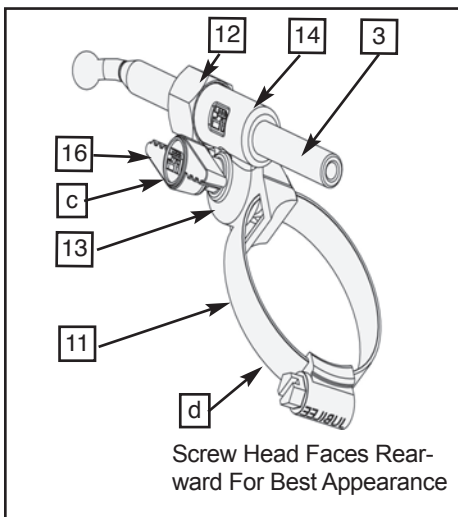

Figure 10a

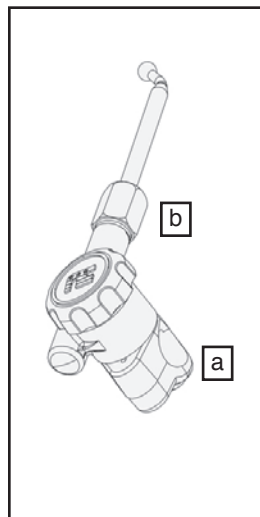

Figure 11

## ENJOY YOUR NEW STREET SHIELD™ WINDSHIELD